

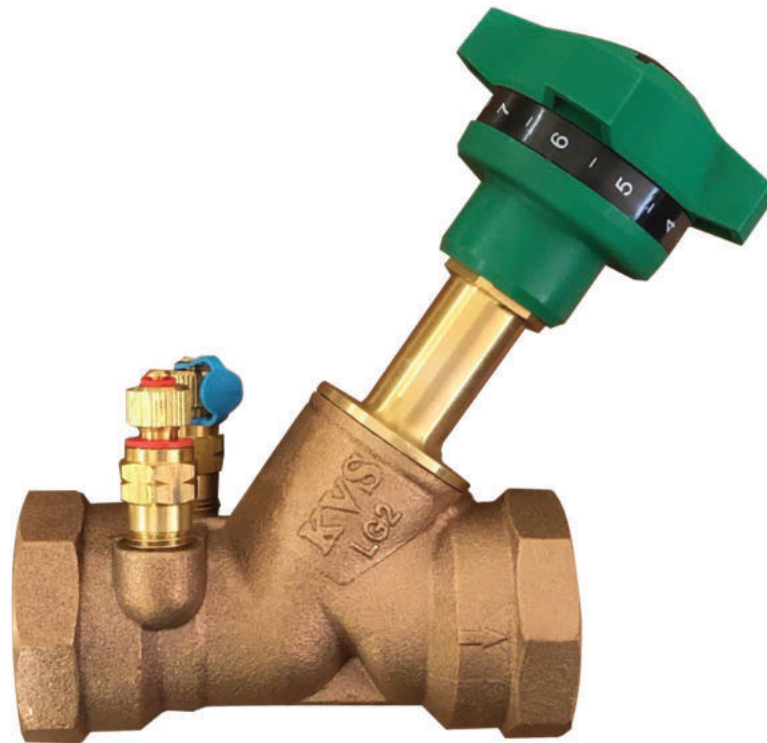

BRONZE BALANCING VALVE

Model: KVS - 2870



SPECIFICATION

- Designed to BS 7350
- Pressure Rating: PN25
- Working Medium: Water, Oil
- Working Temperature: < 120°C
- Handwheel operated
- Numerical Indicator
- Inside screw non-rising handwheel
- Characterized regulating disc
- Integral fixed orifice
- Supplied with 2 test points
- BS21Taper Threaded (ISO 7) / BS EN10226-2
- Superior to variable orifice DRV due to higher accuracy from integral fixed orifice.
- Valve must be installed fully in accordance with instructions.



BRONZE BALANCING VALVE

Model: KVS - 2870

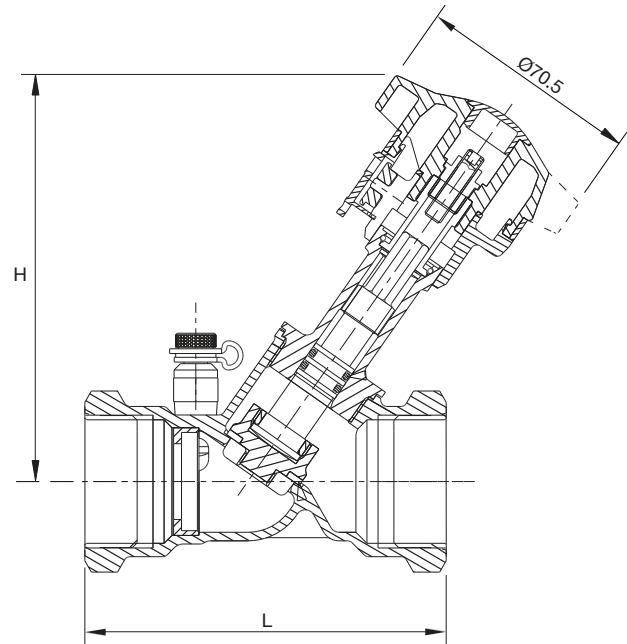
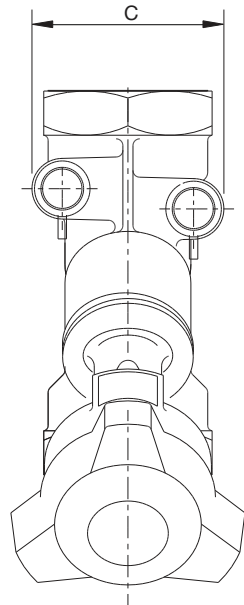

MATERIALS

Description	Material
Body	Bronze CC491K
Bonnet (1/2" - 1 1/4")	DZR Brass CW602N
Bonnet (1 1/2" - 2")	Bronze CC491K
Stem	DZR Brass CW602N
Disc	DZR Brass CW602N
Handwheel	Plastic
Orifice Insert	DZR Brass CW602N
Press. Test Points	DZR Brass CW602N

DIMENSIONS (mm)

Inches	DN		L	H	C
		MM			
1/2"		15	87	105	46
3/4"		20	96	106	51
1"		25	100	127	56
1 1/4"		32	114	128	57
1 1/2"		40	125	143	61
2"		50	146	144	75



BRONZE BALANCING VALVE

Model: KVS - 2870

FLOW DATA MANUAL

KVs FIXED ORIFICE

Size	DN 15	DN 20	DN 25	DN 32	DN 40	DN 50
KVs	2.2	4.6	8.5	16.7	26.1	43.2

Kv WHOLE VALVE

Hand wheel position	DN 15	DN 20	DN 25	DN 32	DN 40	DN 50
1.0	0.29	0.40	0.92	0.72	1.28	1.95
1.5	0.46	0.59	1.34	1.17	2.20	5.55
2.0	0.63	0.80	1.77	3.52	5.00	12.0
2.5	0.85	1.49	2.29	6.59	9.89	18.5
3.0	1.27	2.11	3.42	8.81	14.5	23.5
3.5	1.64	2.80	4.82	10.1	16.8	26.6
4.0	1.87	3.14	5.59	10.8	18.1	29.1



BRONZE BALANCING VALVE

Model: KVS - 2870

Flow Measurement Graphs

Fixed orifice devices for standard applications

Size 1/2" (DN15mm)

$K_{vs}=2.2$

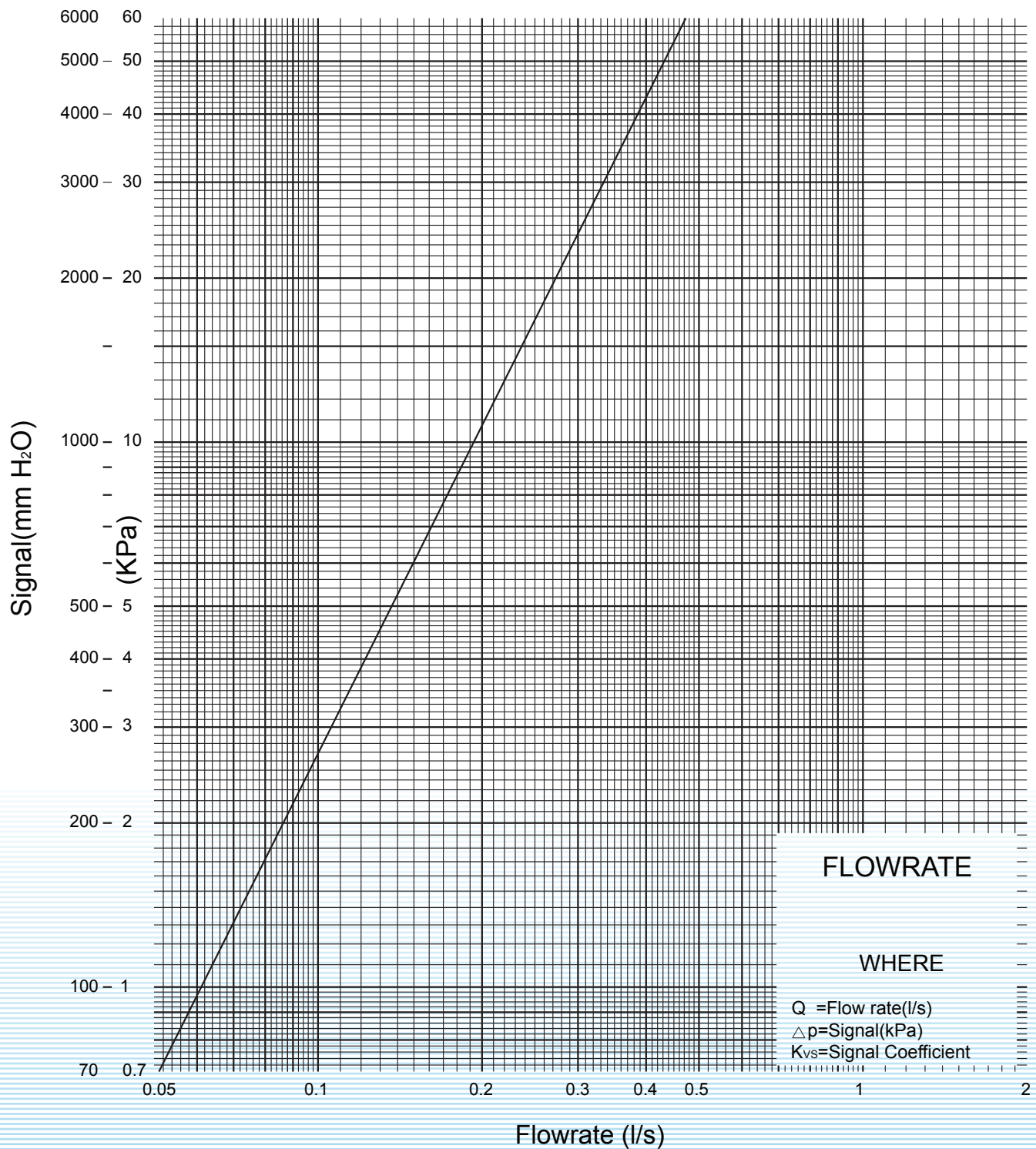



BRONZE BALANCING VALVE

Model: KVS - 2870

Flow Measurement Graphs

Fixed orifice devices for standard applications

Size 3/4" (DN20mm)

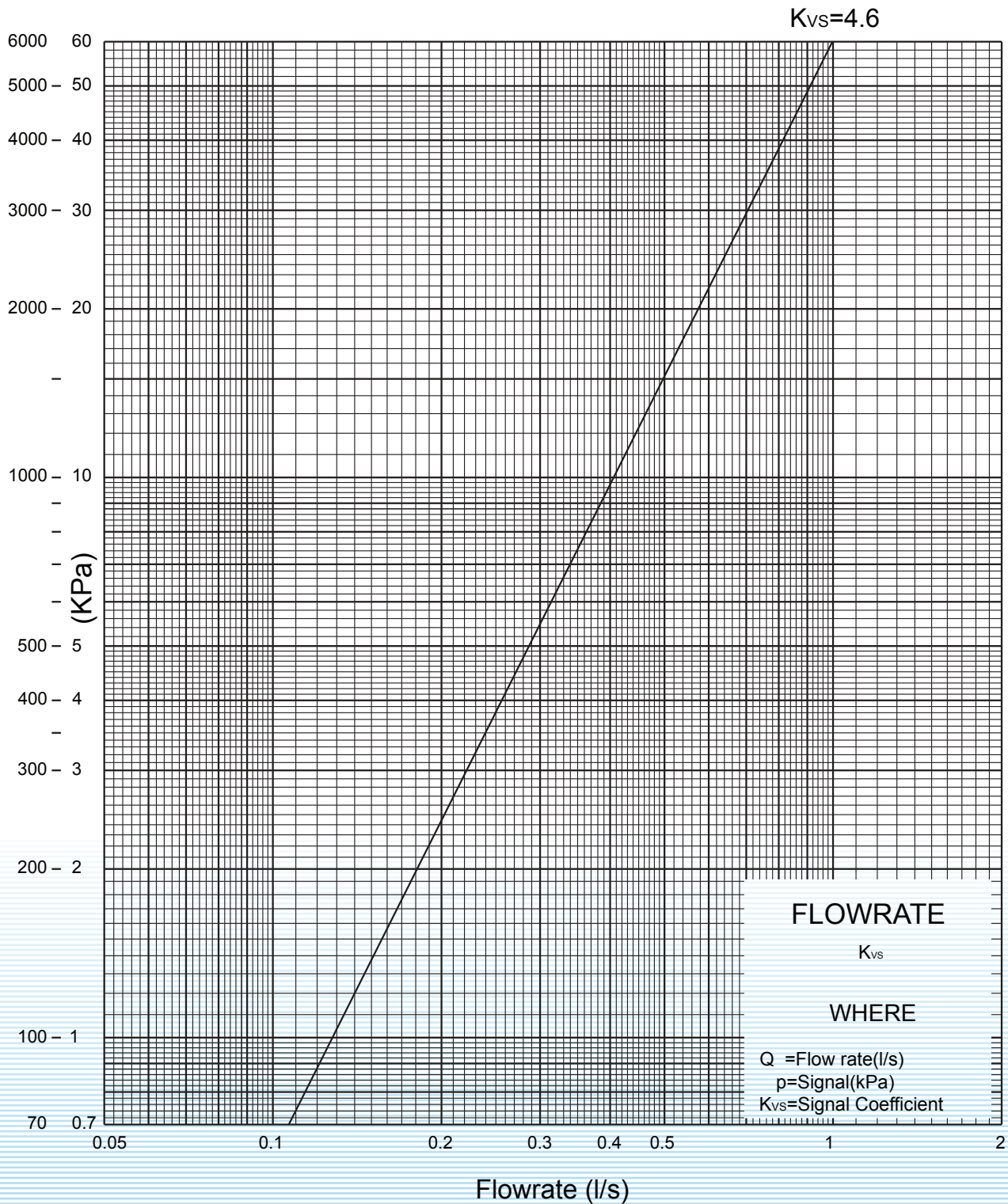



BRONZE BALANCING VALVE

Model: KVS - 2870

Flow Measurement Graphs

Fixed orifice devices for standard applications

Size 1" (DN25mm)

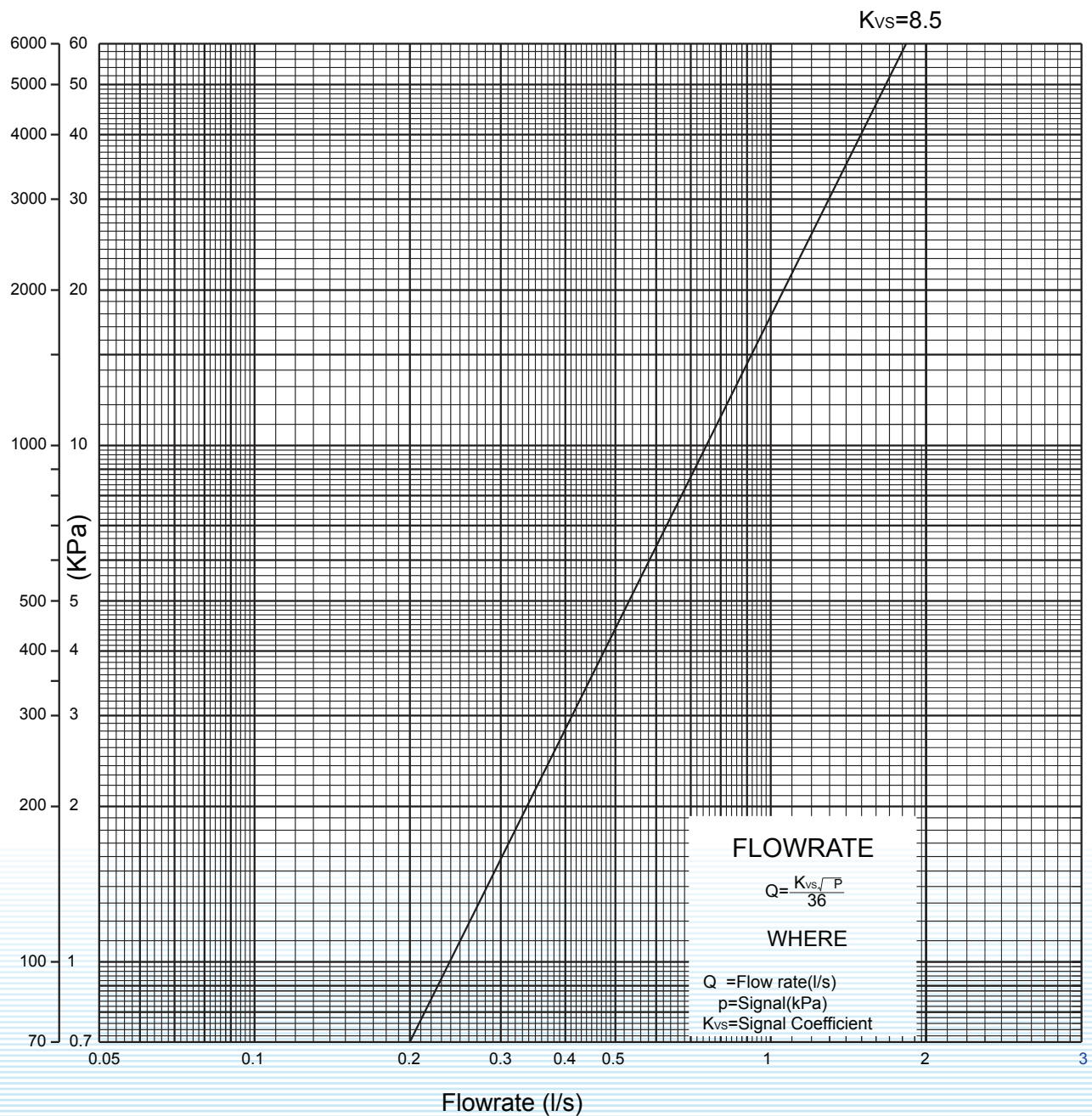



BRONZE BALANCING VALVE

Model: KVS - 2870

Flow Measurement Graphs

Fixed orifice devices for standard applications

Size 1-1/4" (DN32mm)

$K_{vs}=16.7$

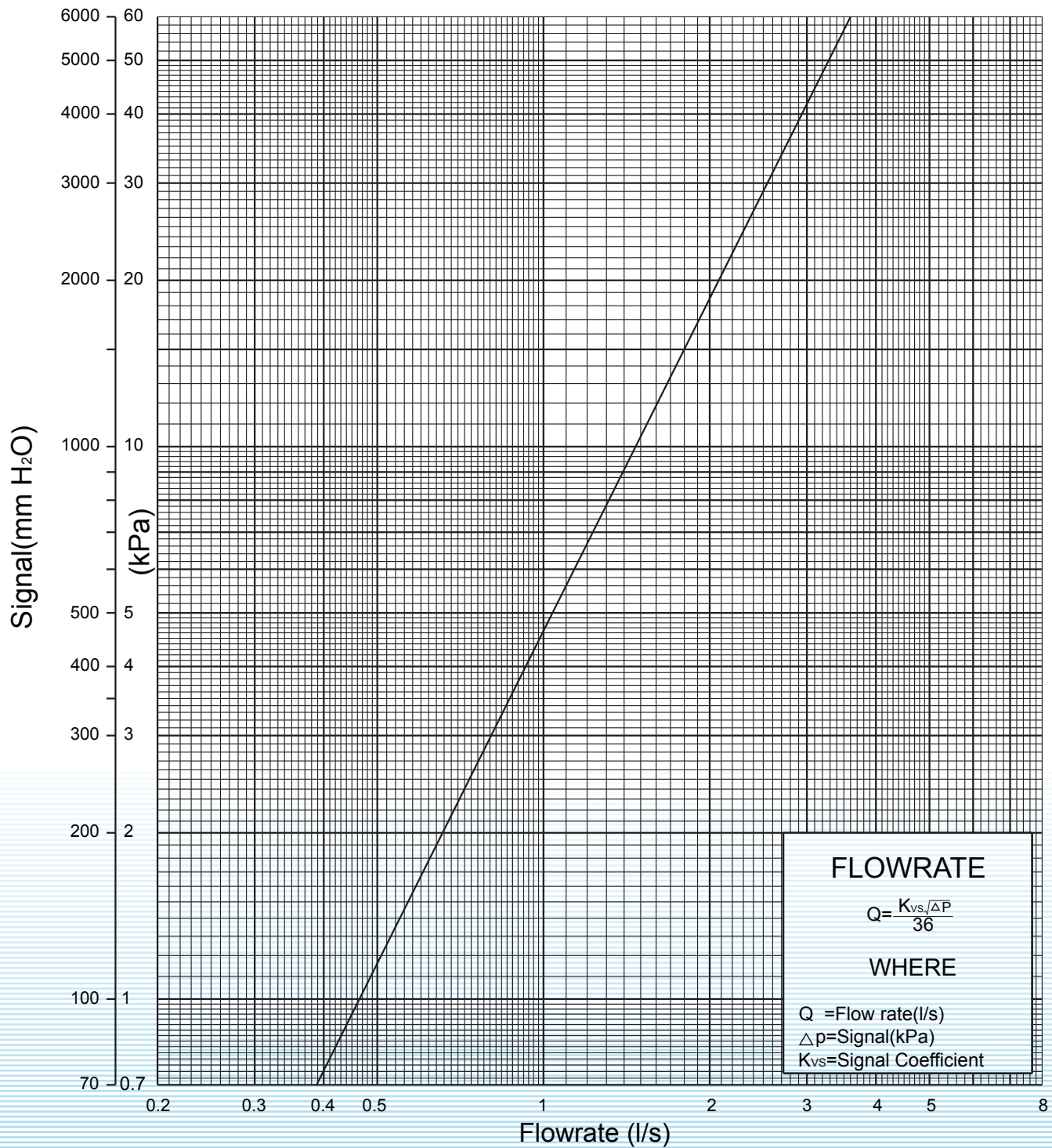



BRONZE BALANCING VALVE

Model: KVS - 2870

Flow Measurement Graphs

Fixed orifice devices for standard applications

Size 1-1/2" (DN40mm)

$K_{vs}=26.1$

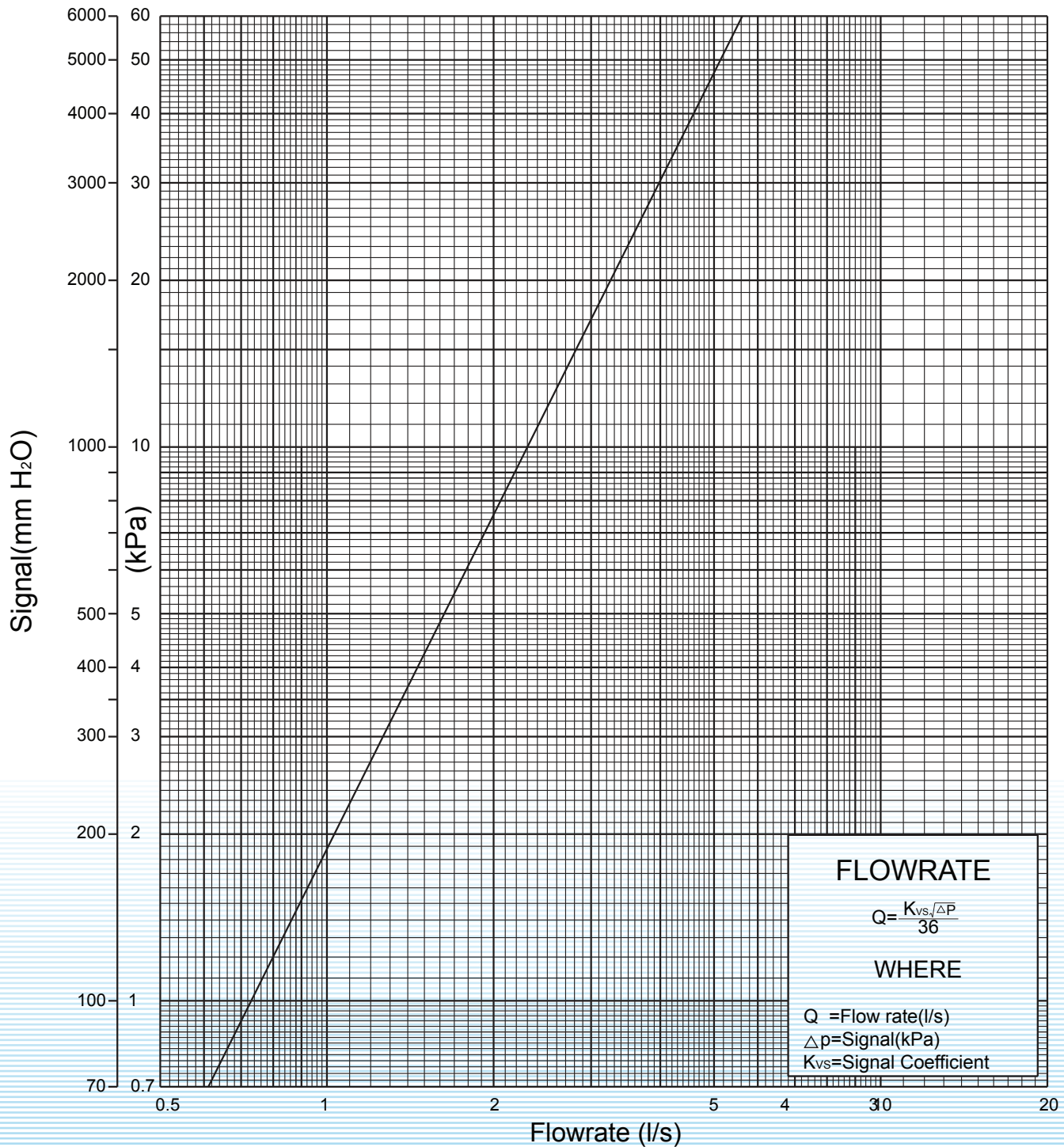



BRONZE BALANCING VALVE

Model: KVS - 2870

Flow Measurement Graphs

Fixed orifice devices for standard applications

Size 2" (DN50mm)

K = 43.2

